

1. Aşağıdaki elektrik devrelerindeki ampullerden seri bağlı olanların altlarındaki kutucuğa "S", paralel bağlı olanların altındaki kutucuğa "P" harfini yazınız.

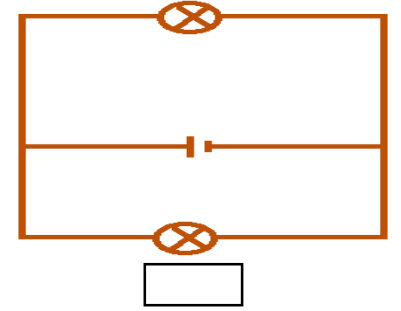

2. Aşağıdaki devrelerde ampermetre ve voltmetreler farklı şekillerde bağlanmıştır. Ampermetre ve voltmetrenin doğru olarak bağlandığı devrelerin altlarındaki kutucukları "X" ile işaretleyiniz.

(Ampermetre devreye seri, voltmetre devreye paralel bağlanır.)

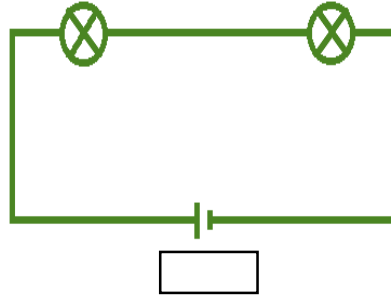
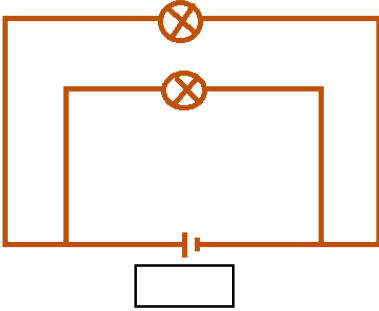
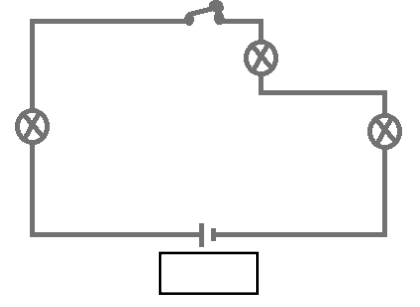
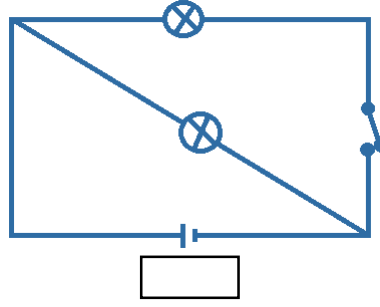
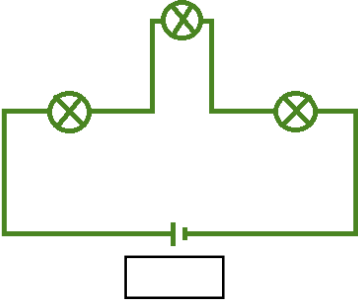
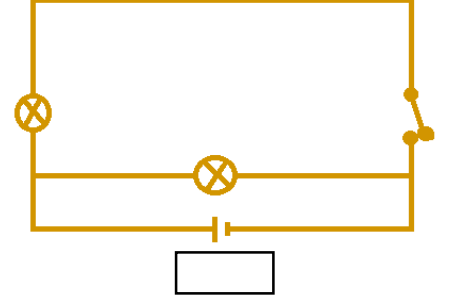
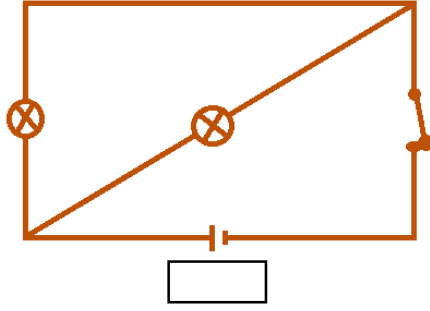
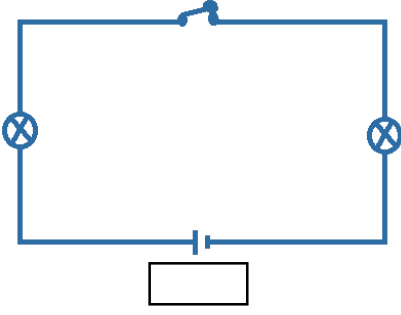
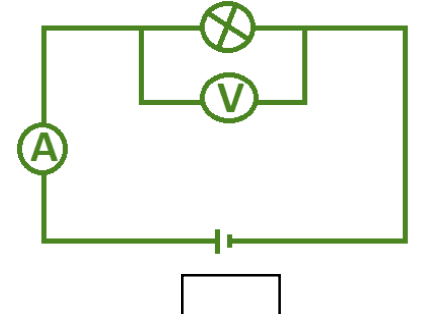
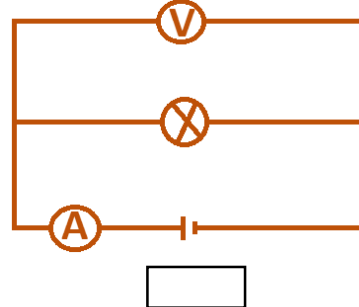
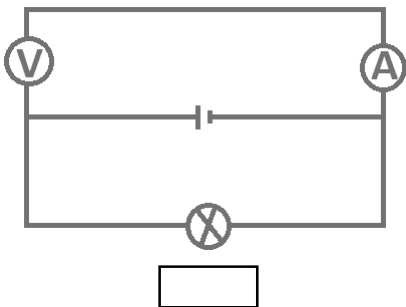
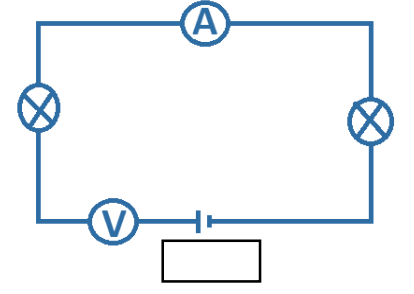
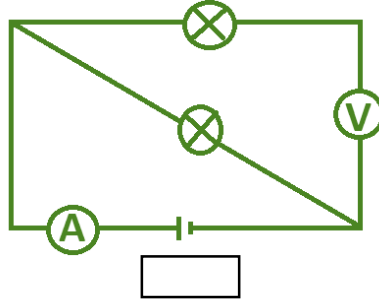
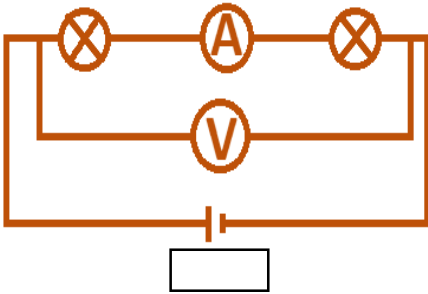

3. Özdeş pil ve lambalarla kurulan elektrik devrelerindeki ampul parlaklıklarının büyükten küçüğe doğru sıralamasını devrelerin altındaki noktalı yerlere yazınız.

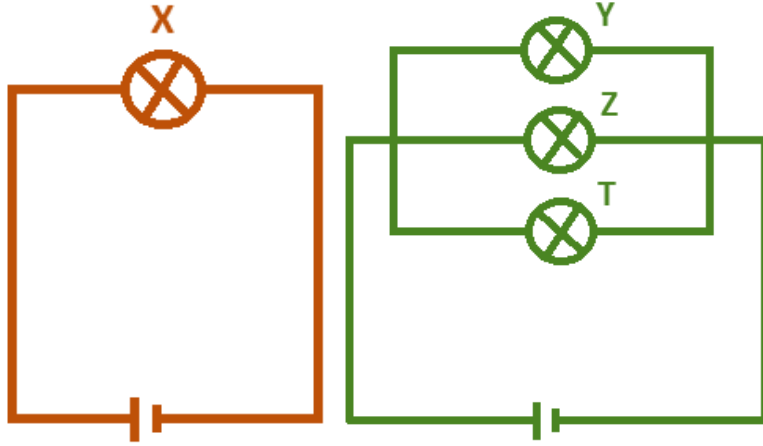
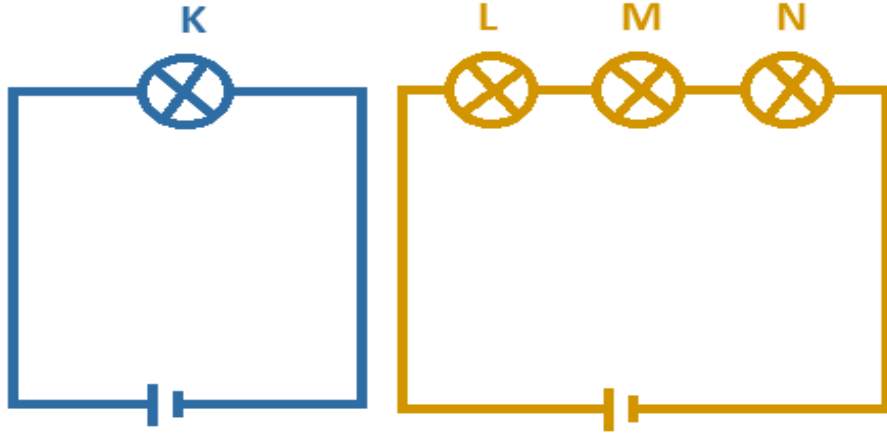

4. Özdeş ampullerle kurulan aşağıdaki elektrik devresindeki seri ve paralel bağlı ampullerin isimlerini tablodaki ilgili yerlere yazınız.

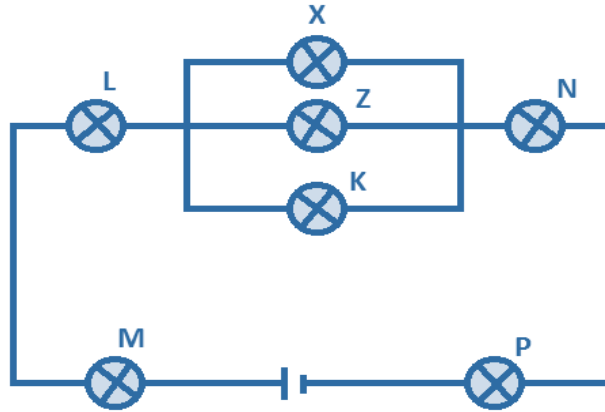

SERİ BAĞLI AMPULLER	PARALEL BAĞLI AMPULLER